

Product brochure

SediPipe® 800

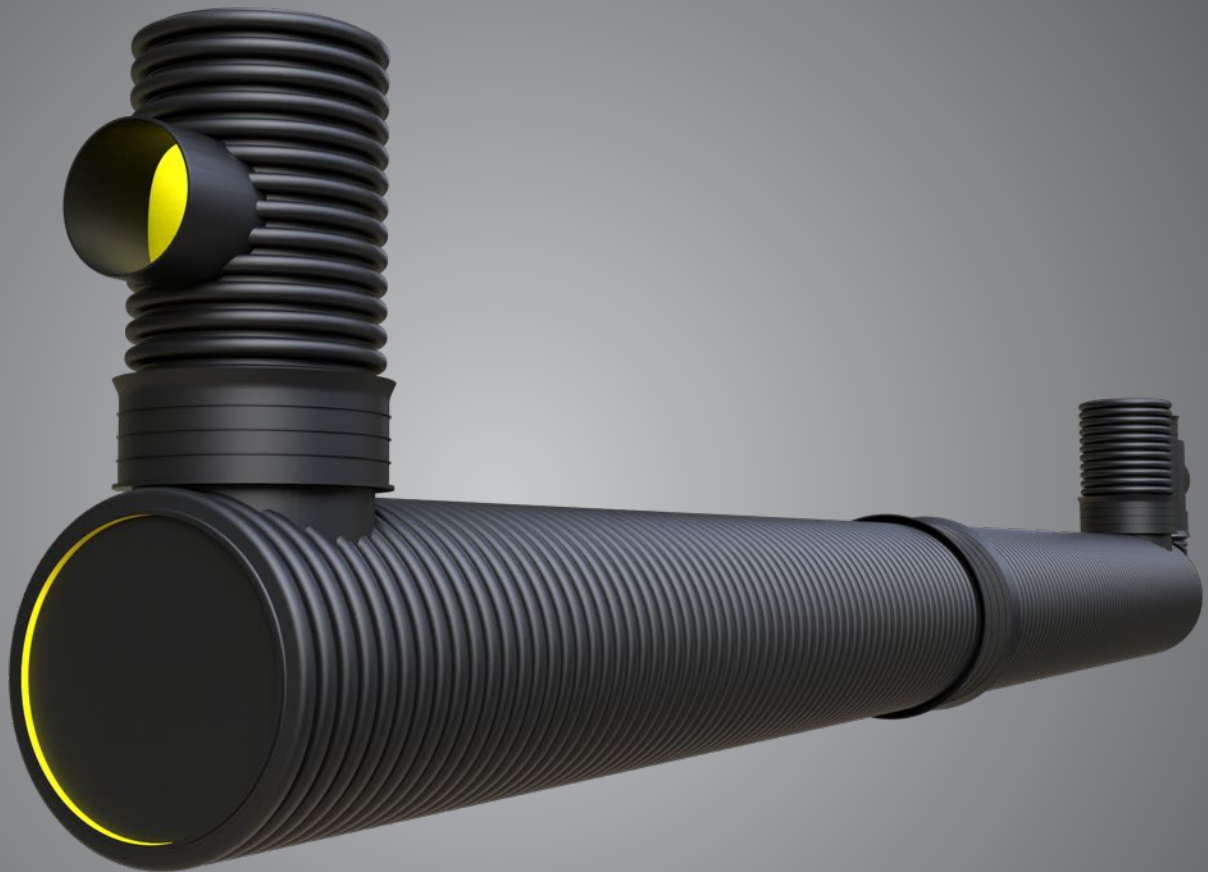

A new dimension of stormwater treatment



Stormwater treatment fundamentals

Operational reliability and protection of waterbodies

Collected stormwater can be polluted with different materials, e.g., coarse dirt, mud and light liquids from road traffic or industrial facilities. These materials can cause malfunctions of stormwater management systems such as infiltration swales. In addition, they can pose a threat to downstream waterbodies or the groundwater. In these cases, stormwater requires treatment prior to discharge or infiltration. This treatment shall verifiably meet the specific operational requirements, as well as regulations under the Water Act according to the generally accepted codes of practice.

Table of contents

Stormwater treatment fundamentals	2
Sources of pollution of stormwater runoff	4
SediPipe® 800	7
Functional principle	10
Installation examples	12
Advantages	14
SediPipe® 800 – complies with DWA-A 102-2	15
Performance parameters according to DWA-A 102-2	16
Performance parameters according to DWA-M 153	17
Cleaning	20
Connection geometries	21
Technical data	22
Product range overview	24
Contact	27

General information on using our products and systems:

Information about or assessments of the use and installation of our products and systems is exclusively provided on the basis of the information submitted. We do not assume any liability for damage caused by incomplete information. If the actual situation deviates from the planned situation or if a new situation occurs or if different or new installation techniques are applied, these must be agreed upon with FRÄNKISCHE, since these situations or techniques may lead to different conclusions. Notwithstanding the above, the customer is solely responsible for verifying the suitability of our products and systems for the intended purpose. In addition, we do not assume any liability or responsibility for system characteristics and system functionalities when third-party products or accessories are used in combination with FRÄNKISCHE systems. We only assume liability if original FRÄNKISCHE products are used. For use in other countries than Germany, country-specific standards and regulations must also be observed.

All information provided in this publication is generally up to date at the time of printing. Moreover, this publication was prepared with the greatest possible care. However, we cannot rule out printing errors or translation mistakes. Furthermore, we reserve the right to change products, specifications and other information, or changes may be necessary due to legal, material or other technical requirements, which no longer could be considered for this publication. For this reason, we cannot assume any liability which is based solely on the data provided in this publication. Instrumental in connection with information about products or services is always the purchase order, the respective product purchased and the related documentation or the information provided by our specialist staff in the specific case.

Sources of pollution of stormwater runoff



Industrial areas & business parks

Dust, oil, sediments, toxic substances, heavy metals, gritting agents



Pollution of stormwater due to impervious surfaces

Rain falls on roads, squares, roofs, stadiums and many other surfaces. Wherever stormwater cannot be treated naturally, our competencies are needed: namely the protection of waterbodies and storage/infiltration systems from discharge polluted with substances. Rocks, leaves, sand and especially fine and ultra-fine particles must be removed from stormwater to shield the storage/infiltration system from this dirt. To protect the environment, stormwater needs to be cleared of particle-bound and dissolved pollutants such as heavy metals and PAH as well as oil.



Private properties
Sediments, plant remains,
gritting materials

Public area
Waste, sediment,
plant remains, pollen

Traffic areas
Dust, oil, sediments,
tyre wear, brake dust,
heavy metals,
gritting agents



Treatment using SediPipe® sedimentation systems

To remove dirt and pollutants from stormwater, technical solutions such as SediPipe 800 are called for, since these can fulfil this task highly efficiently, reliably, durably and with as little maintenance as possible.



SediPipe® 800

Larger systems with regard to the new DWA-A102 regulations

FRÄNKISCHE is reacting to the increased performance requirements for stormwater treatment systems according to DWA-A 102/BWK-A 3: The new SediPipe 800 system expands its range and will cover large to very large connectable areas in the future. The modular system offers proven high treatment performance, confirmed by a professionally recognised verification procedure.

The design of the flexible system has been optimised. The large-volume system with sedimentation pipes in DN 800 features our tried-and-tested flow separator technology.

Even bigger, even more flexible, even more possibilities

Larger connectable area, more volume and more treatment performance: With the new SediPipe 800 system, FRÄNKISCHE meets the increased requirements on stormwater treatment and now offers matching solutions for any application. The modular design allows standard system sizes from 12 to 48 metres. The components are easy to order, available at short notice and will be delivered in no time. Because the SediPipe system is installed completely underground, the surface may be used for other purposes.



Optimised handling

SediPipe 800 facilitates construction site handling: The large-volume system consists of only a few, space-saving individual components. SediPipe 800 is also easy to retrofit in existing systems: The new model quickly expands existing stormwater sewers into an integrated stormwater treatment system. The inspection openings integrated in the start and target segments ensure control and maintenance using sewer inspection equipment.

NEW DIMENSIONS

DN 800



**IDEAL
layout**

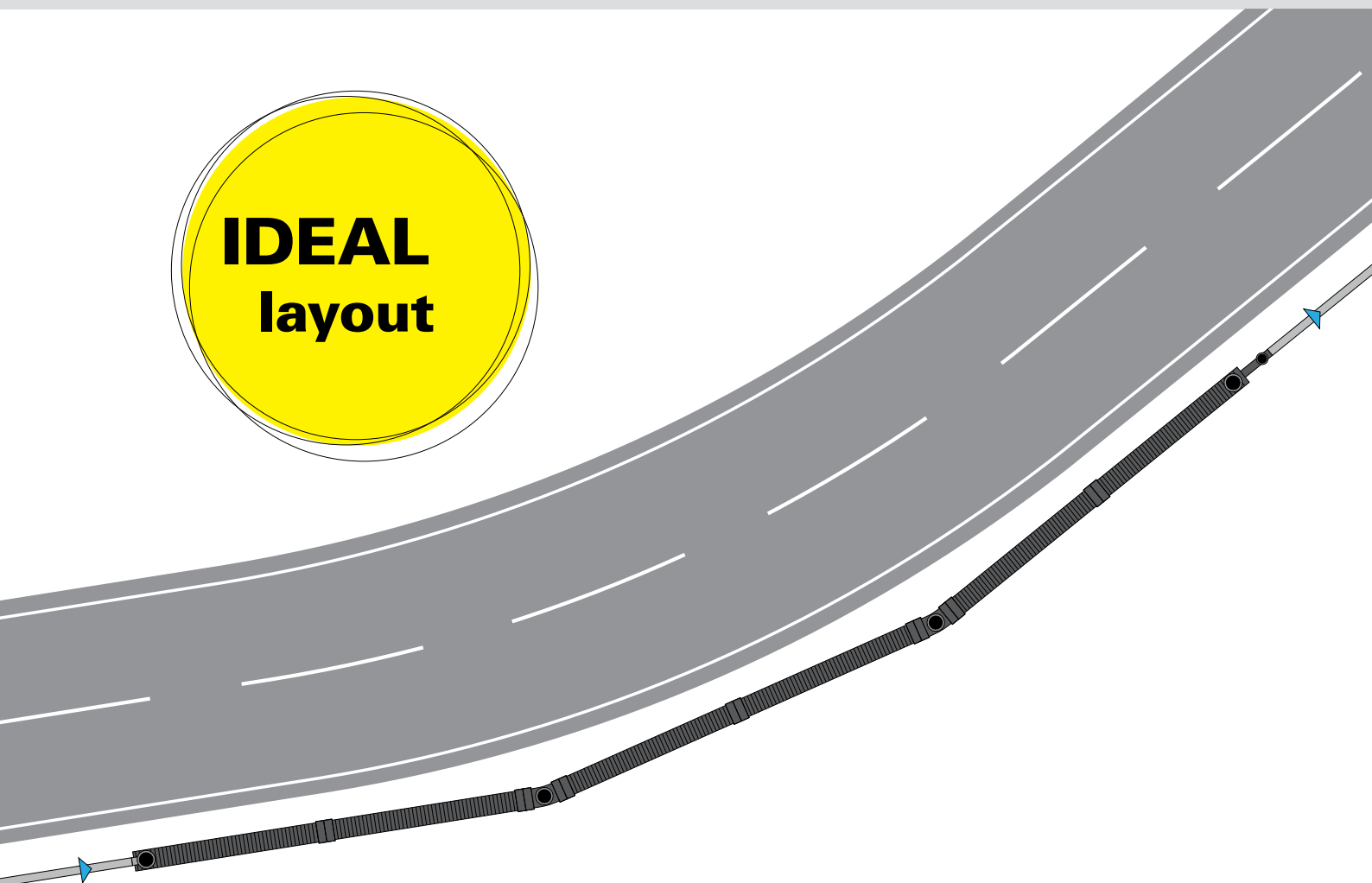



NEW DIMENSIONS



- 48 m
- 42 m
- 36 m
- 30 m
- 24 m
- 18 m
- 12 m

Functional principle

Flow separator technology – the patented operating principle

For the sustainable protection of waterbodies and soils, all treatment systems of the SediPipe family use FRÄNKISCHE's patented flow separator technology. The flow separator in the lower pipe section forms an area with little water movement where sediments and pollutants adhering to them settle quickly and are protected against remobilisation or re-entrainment.

The stretched and compact sedimentation chamber ensures short times and distances until sediment settles and guarantees an optimised treatment performance. Sediment already settled cannot be remobilised even in case of heavy rains. The long and narrow design integrates optimally into the channel route, regardless of whether along stretched structures such as roads, at the inlet to storage/infiltration systems or in case of modernisation of a discharge point into surface waterbodies under the German Water Act.

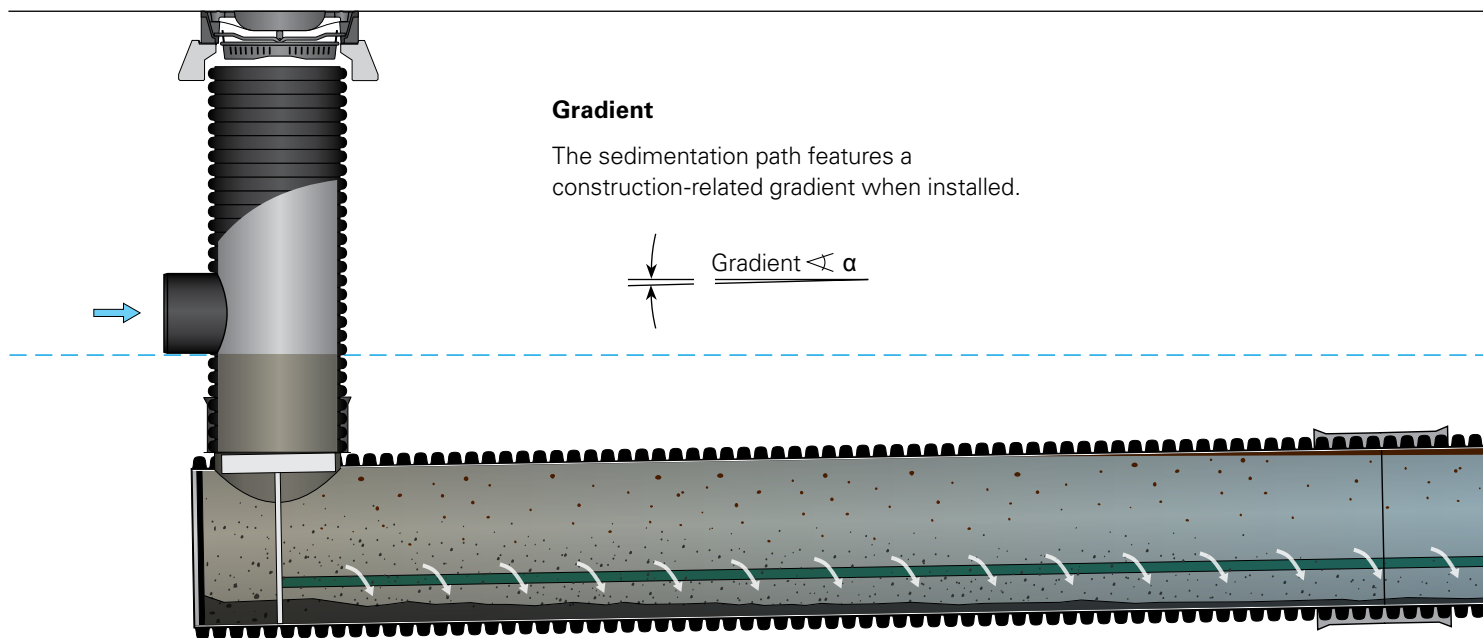

Coarse dirt particles settle already in the start segment. The separated section in the start segment works as a mud collector.

Optimised sedimentation process of fine particles

The stretched and compact sedimentation chamber reduces the time and distance until particles settle, and causes flow harmonisation. Both factors together prevent turbulences and thus ensure an optimal sedimentation process.

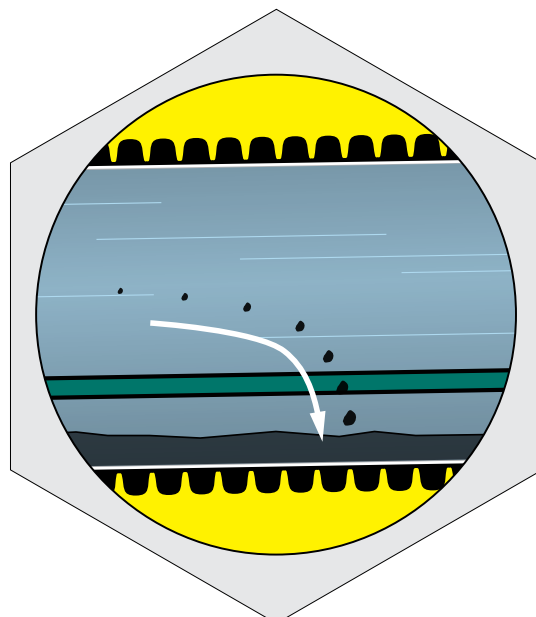

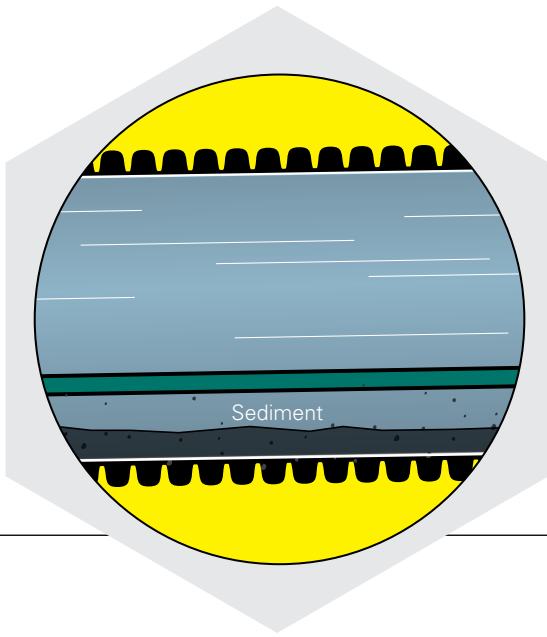

Flow separator technology

The patented flow separator technology creates an area with little water movement in the depot, thus preventing remobilisation of the sediment already settled even in case of heavy rains.

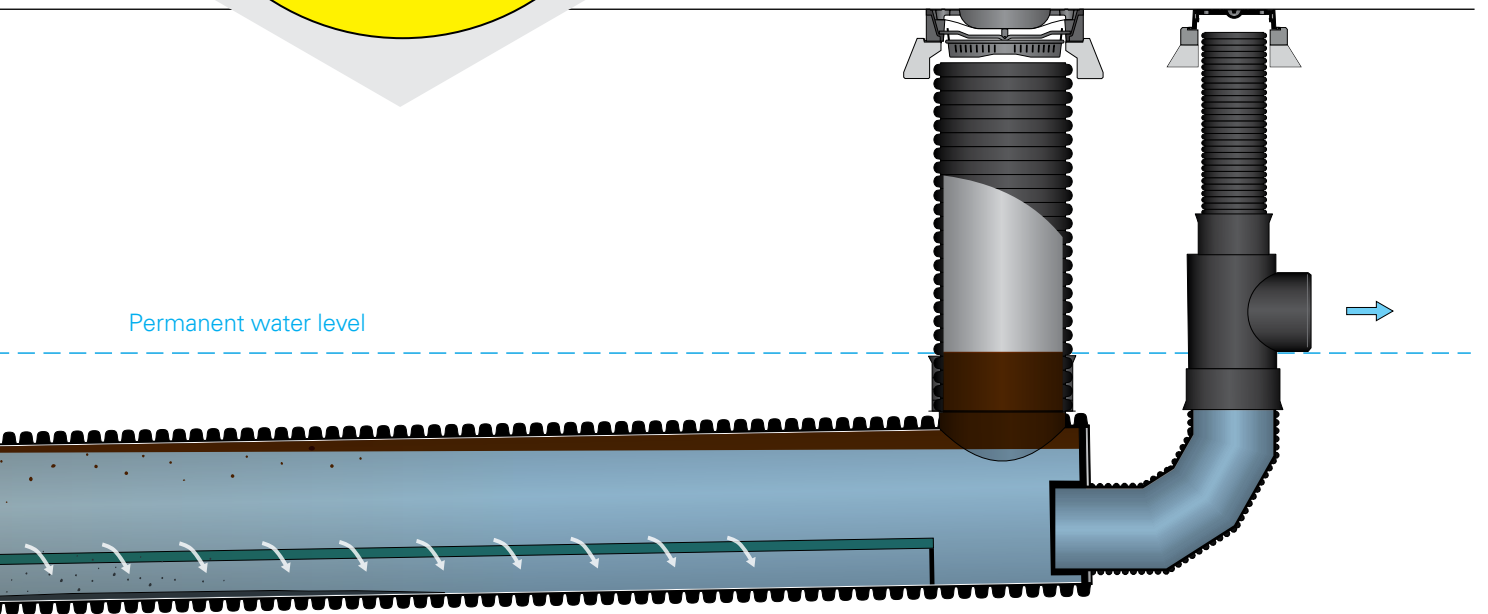

Retention of light liquids

Due to the slight gradient of the pipe, light liquids that rise upwards in the sedimentation path enter the upper section of the target segment in which these are collected.

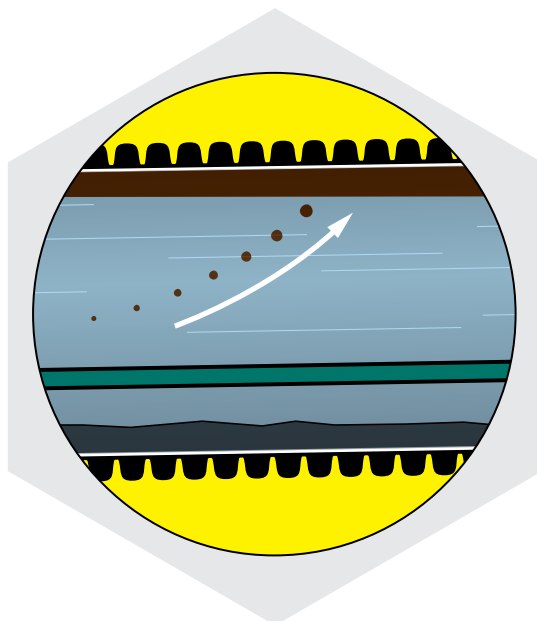

Installation examples

Ideal layout – direct integration into the existing sewer

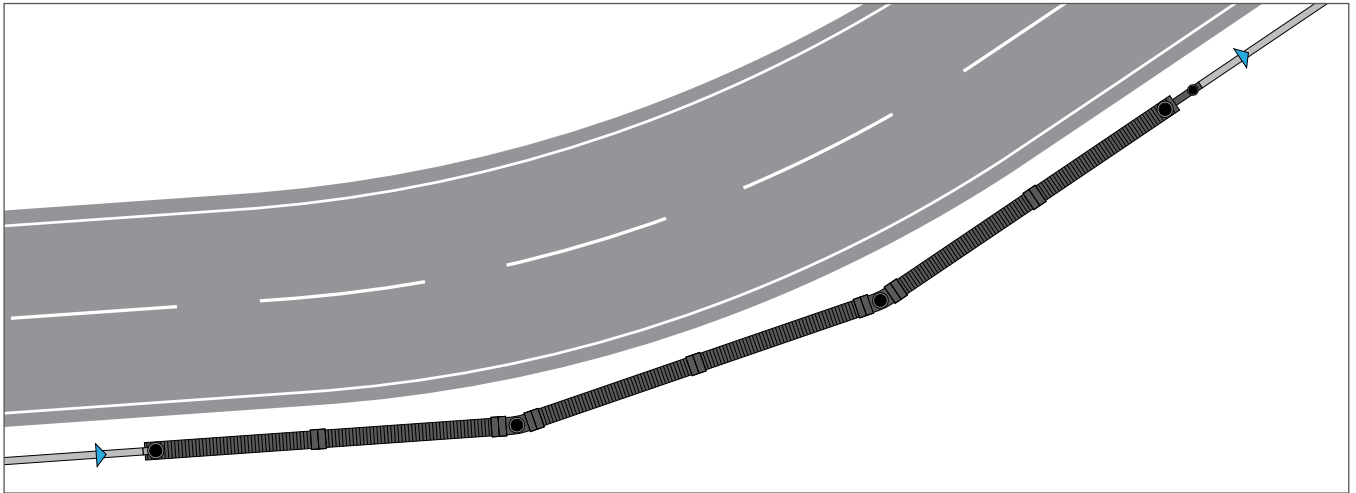

Multiple parallel arrangement for very large connectable areas

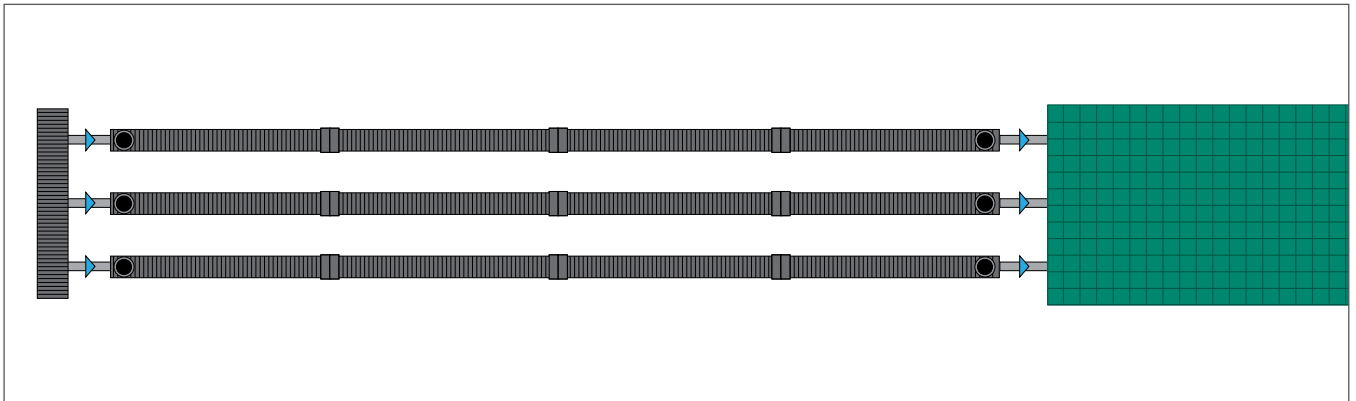

Space-saving along the storage/infiltration system

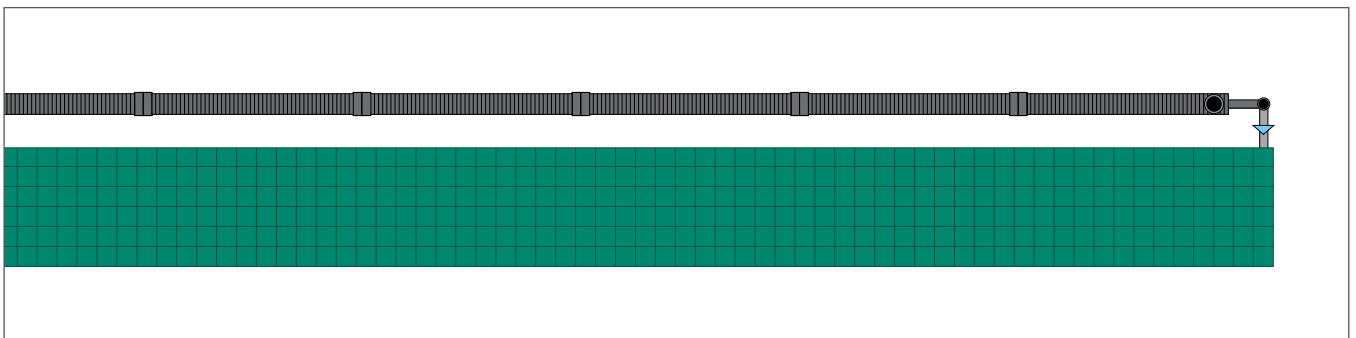

Installation under existing media

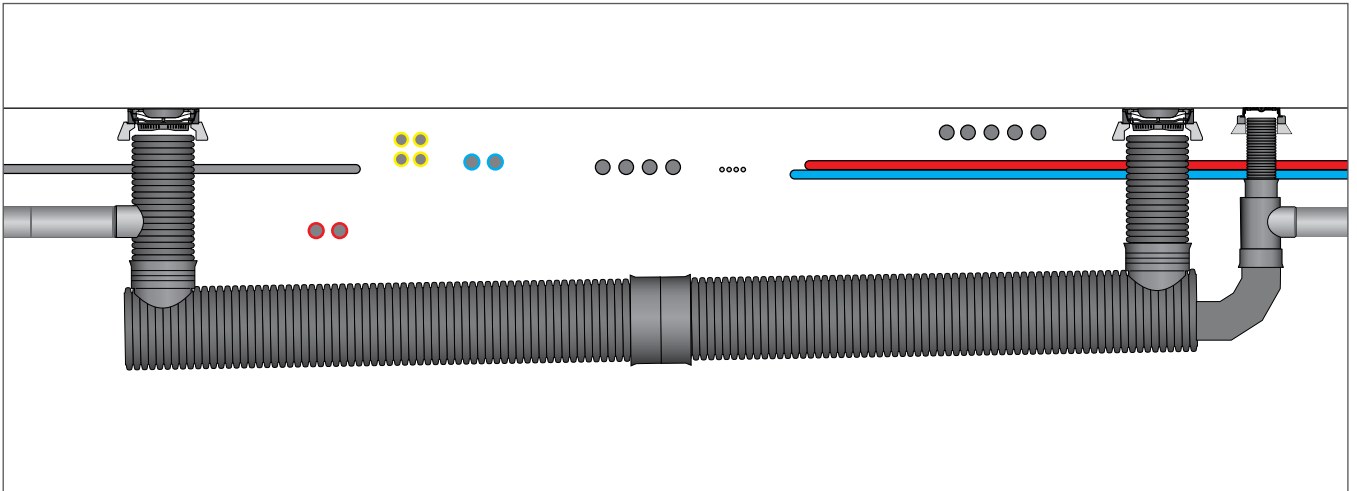

Free connection and outlet angles

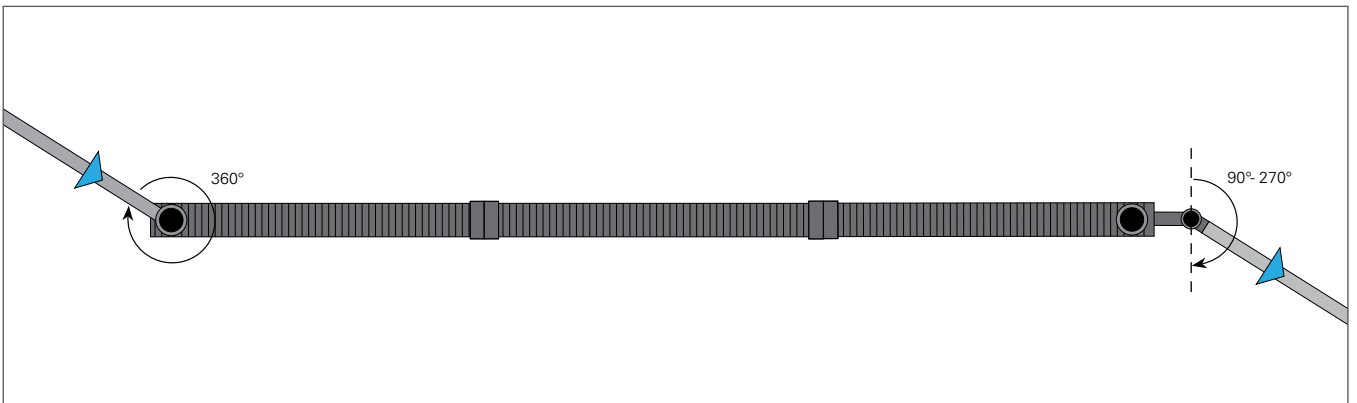

Advantages

Proven treatment performance and sediment control

Optimised sedimentation process and retention of fine particles thanks to flow harmonisation

**DWA
A102-2**
compliant

For large to very large connectable areas

Quick and easy installation

No space on the surface required (fully underground installation)

Space-saving arrangement, minimised construction field (on the channel route, under existing media)

Easy cleaning using common sewer cleaning equipment

Greatest flexibility because depth and connection angle can be adjusted on site

Allows angles or changes of direction

No additional, separate start and target shaft

Retrofitting in existing sewers possible

SediPipe® 800 – complies with DWA-A 102-2

New requirements regarding stormwater treatment

The best possible technology for stormwater treatment has been redefined: The new DWA-A 102/BWK-A 3 regulations replace the DWA-M 153 bulletin with regard to discharging stormwater into surface waterbodies.

DWA-A 102-2 describes: SPECIAL FORMS

For the first time, factory-made so-called special forms of treatment systems have been considered explicitly in the regulations. Therefore, FRÄNKISCHE SediPipe sedimentation systems are now officially defined as treatment systems according to generally acknowledged rules of technology.



DWA-A 102-2 requires: VERIFICATION PROCEDURE FOR SPECIAL FORMS

The residence time method has exclusively been developed for SediPipe sedimentation systems by FRÄNKISCHE. Characteristics of the model are the residence time calculation of the water overflowing at a point in time t instead of a stationary flow rate, and the approach of using the sedimentation process depending on this residence time, as well as a long-term simulation. This model fundamentally considers the special flow separator technology by FRÄNKISCHE, which enables optimum design of the system to create the essentially required plug flow as well as batch behaviour.



DWA-A 102-2 requires: HIGH-PERFORMANCE AND EFFICIENT TREATMENT SYSTEMS

FRÄNKISCHE has been doing long-term and sound development work for its treatment systems – together with recognised institutes. Our flow separator technology is a proven efficient operating principle and is the key to the success of our systems. It guarantees high and efficient separation performance of suspended solids AFS63.



DWA-A 102-2 requires: EFFICIENT TREATMENT SYSTEMS

Due to the very versatile SediPipe product range, our treatment systems can be adjusted exactly to on-site requirements. Decentralised individual systems or centralised multiple systems can be easily implemented in various sizes with our compact and modular designs. The flexibility of planning guarantees individually adjusted solutions with maximum effectiveness and efficiency.

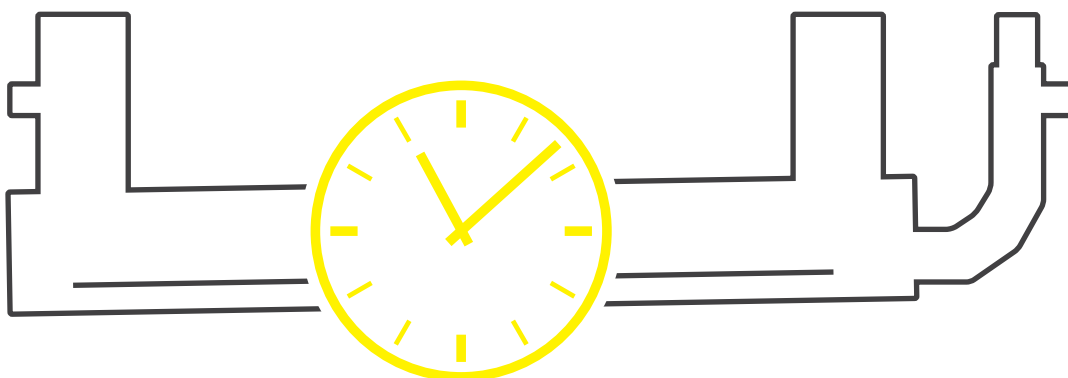

Performance parameters according to DWA-A 102-2

Applications for SediPipe® 800 according to DWA-A 102-2

Example

With 530 kg/(ha·a) AFS63 surface removal, some 1.51 ha of surface can be connected to a SediPipe 800/24 system (without tank overflow).

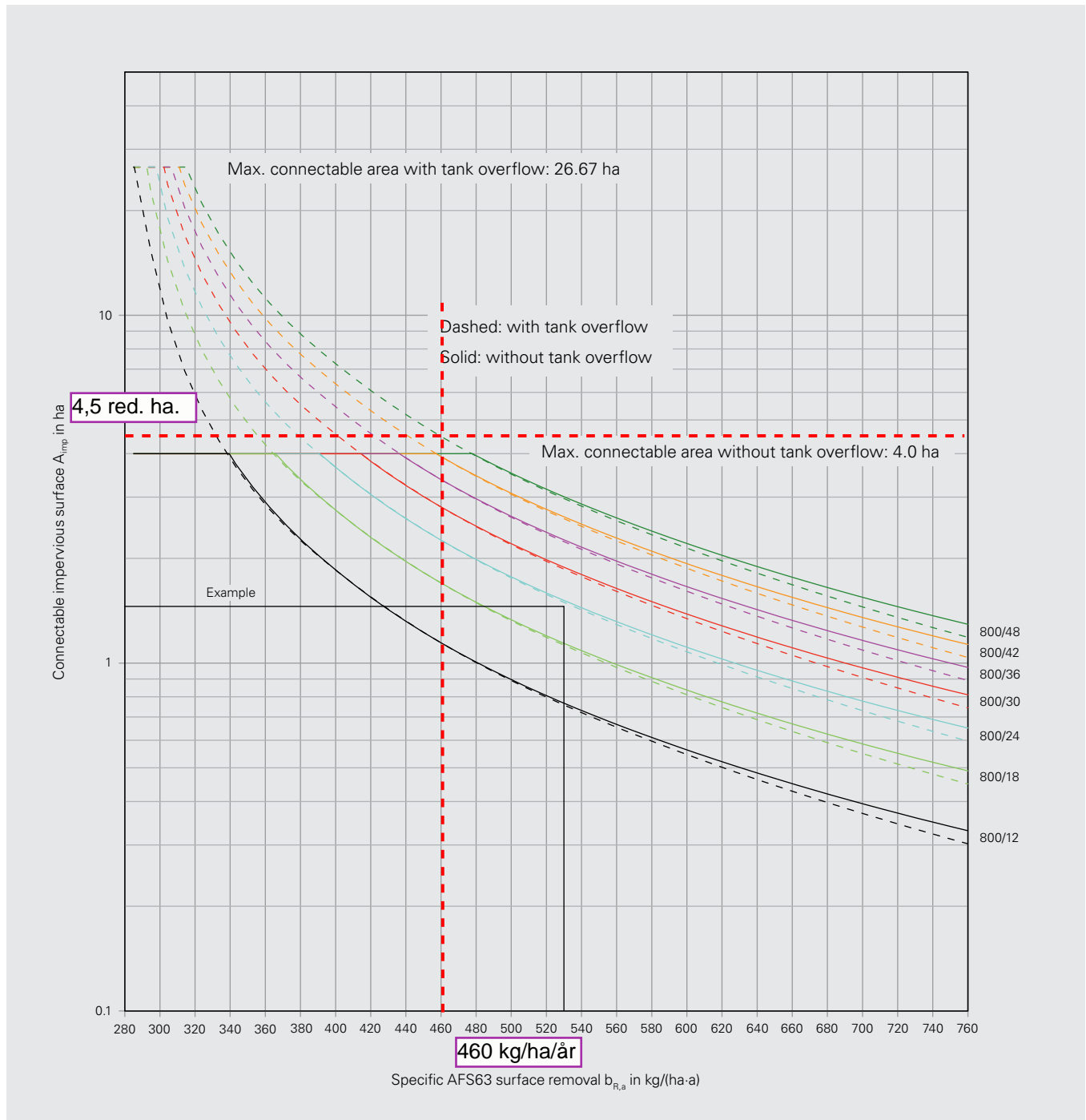

SediPipe 800 dimensioning diagram

Performance parameters according to DWA-M 153

Applications for SediPipe® 800 according to DWA-M 153 table A.4c type D25

Type D25 sedimentation systems according to DWA-M 153 are sedimentation systems that have been designed with a maximum flow rate of 18 m/h.

Sedimentation systems are used to sediment solids with a grain diameter greater than 0.1 mm.

D25

Pass-through value acc. to
DWA bulletin M 153

0.80 to 0.35

System type	D25			
Pass-through value	0.80	0.70	0.65	0.35
r_{crit} [l/(s·ha)]	15	30	45	$r_{(15.1)}^{2)}$

SediPipe 800	Connectable area A_{imp} [m ²]			
800/12	25,400 ¹⁾	12,700 ¹⁾	8,450	3,800
800/18	38,050 ¹⁾	19,050 ¹⁾	12,700 ¹⁾	5,700
800/24	50,750 ¹⁾	25,400 ¹⁾	16,900 ¹⁾	7,600
800/30	63,450 ¹⁾	31,750 ¹⁾	21,150 ¹⁾	9,500
800/36	76,150 ¹⁾	38,050 ¹⁾	25,400 ¹⁾	11,400 ¹⁾
800/42	88,850 ¹⁾	44,400 ¹⁾	29,600 ¹⁾	13,300 ¹⁾
800/48	101,500 ¹⁾	50,750 ¹⁾	33,850 ¹⁾	15,250 ¹⁾

¹⁾ As of 10,000 m² A_{imp} (for $r_{dim} = 200$ l/(s·ha)), project-specific hydraulic considerations are required.
Values rounded to whole 50 m².

²⁾ at $r_{(15.1)} = 100$ l/(s·ha)

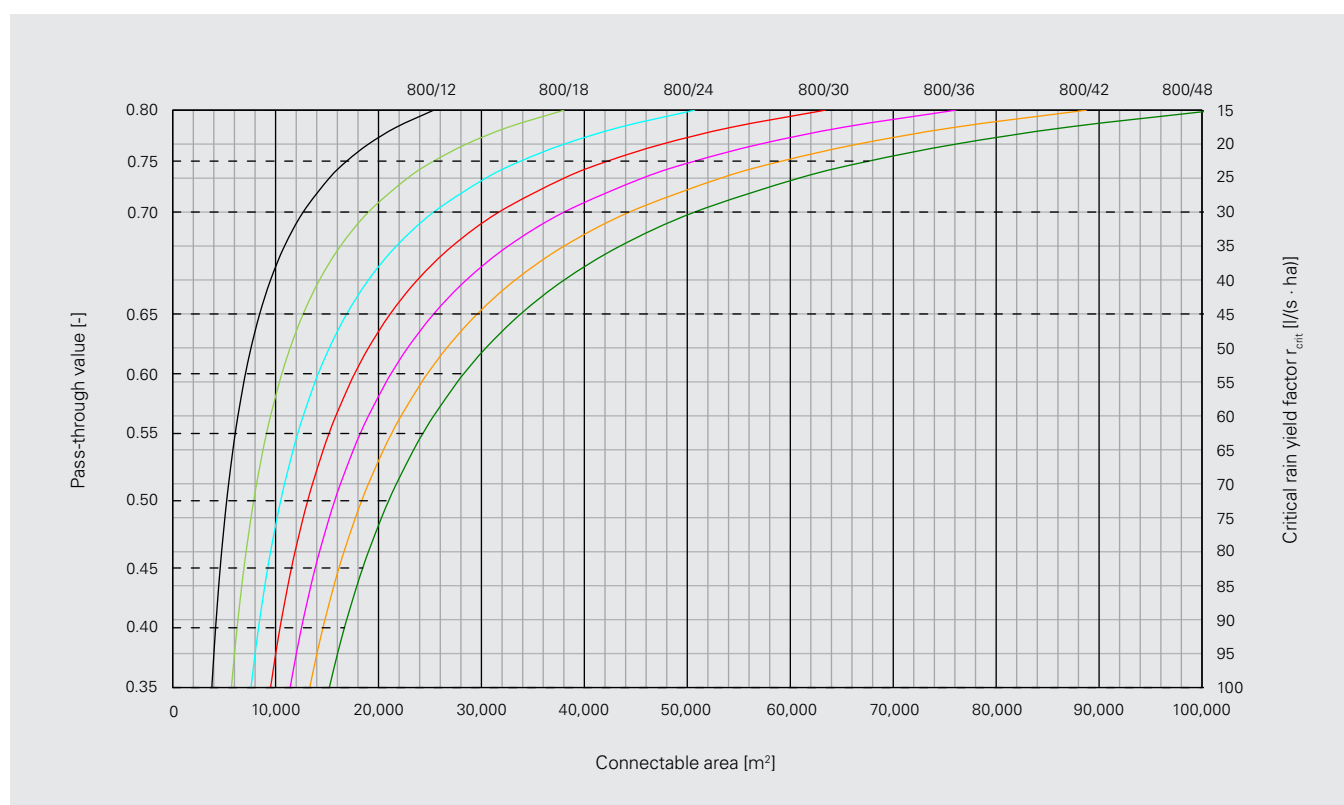

SediPipe 800 performance characteristics, connectable area A_{imp} , depending on the required pass-through value acc. to DWA-M 153, D25

Denne side relevnt

Applications for SediPipe® 800 according to DWA-M 153 table A.4c type D24

Type D24 sedimentation systems according to DWA-M 153 are stormwater sedimentation tanks that have been designed with a maximum flow rate of 10 m/h.

These systems have been designed for the separation of finest grain fractions. In addition, the precipitated sediment must not be swirled up, even with high hydraulic loads. SediPipe meets these requirements.

D24

Pass-through value acc. to
DWA bulletin M 153

0.65 to 0.25

System type	D24			
Pass-through value	0.65	0.55	0.50	0.25
r_{crit} [l/(s·ha)]	15	30	45	$r_{(15,1)}$ ²⁾

NB

Country-specific dimensions, e.g., those of Baden Württemberg (see working aids for handling stormwater in settlement areas ("Arbeitshilfen für den Umgang mit Regenwasser in Siedlungsgebieten"), table 4b) can be calculated, if necessary.

SediPipe 800	Connectable area A_{imp} [m ²]			
800/12	14,100 ¹⁾	7,050	4,700	2,100
800/18	21,150 ¹⁾	10,600 ¹⁾	7,050	3,150
800/24	28,200 ¹⁾	14,100 ¹⁾	9,400	4,250
800/30	35,250 ¹⁾	17,650 ¹⁾	11,750 ¹⁾	5,300
800/36	42,300 ¹⁾	21,150 ¹⁾	14,100 ¹⁾	6,350
800/42	49,350 ¹⁾	24,700 ¹⁾	16,450 ¹⁾	7,400
800/48	56,400 ¹⁾	28,200 ¹⁾	18,800 ¹⁾	8,450

¹⁾ As of 10,000 m² A_{imp} (for $r_{dim} = 200$ l/(s·ha)), project-specific hydraulic considerations are required. Values rounded to whole 50 m².

²⁾ at $r_{(15,1)} = 100$ l/(s·ha)

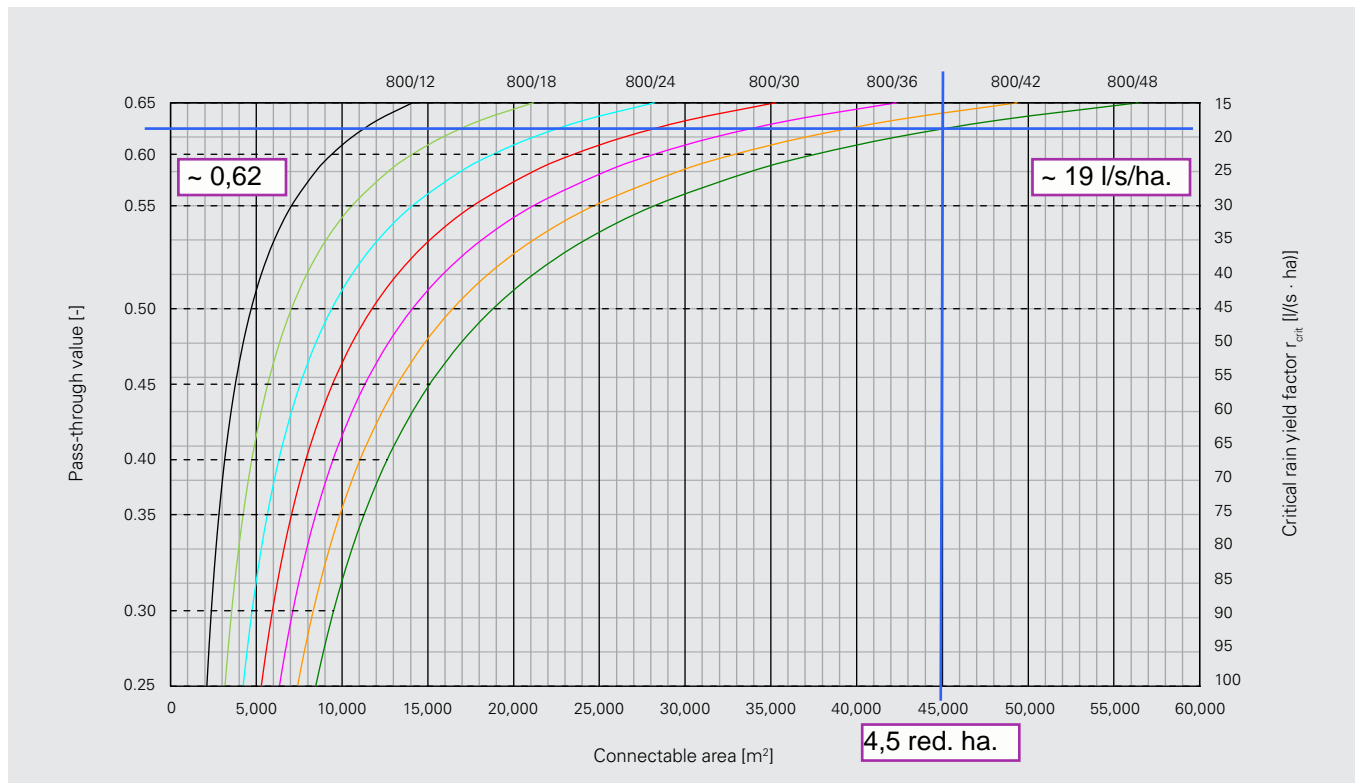

SediPipe 800 performance characteristics, connectable area A_{imp} depending on the required pass-through value acc. to DWA-M 153, D24

Applications for SediPipe® 800 according to DWA-M 153 table A.4c type D21

Type D21 sedimentation systems according to DWA-M 153 are systems with a maximum flow rate of 9 m/h at the load case for rain with the rain yield factor $r_{(15,1)}$ ¹⁾.

These systems have been designed for the separation of finest grain fractions. In addition, the precipitated sediment must not be swirled up, even with high hydraulic loads. SediPoint meets these requirements.

D21

Pass-through value acc. to
DWA bulletin M 153

0.20

System type	D21																
Pass-through value	0.2																
$r_{(15,1)}$ ¹⁾ [l/(s·ha)]	90	95	100	105	110	115	120	125	130	135	140	145	150	155	160	165	170

SediPipe 800	Connectable area A_{imp} [m ²]																
800/12	2,115	2,004	1,904	1,813	1,730	1,655	1,586	1,523	1,464	1,410	1,360	1,313	1,269	1,228	1,190	1,154	1,120
800/18	3,173	3,006	2,855	2,719	2,596	2,483	2,379	2,284	2,196	2,115	2,039	1,969	1,904	1,842	1,785	1,730	1,680
800/24	4,230	4,007	3,807	3,626	3,461	3,310	3,173	3,046	2,928	2,820	2,719	2,626	2,538	2,456	2,379	2,307	2,239
800/30	5,288	5,009	4,759	4,532	4,326	4,138	3,966	3,807	3,661	3,525	3,399	3,282	3,173	3,070	2,974	2,884	2,799
800/36	6,345	6,011	5,711	5,439	5,191	4,966	4,759	4,568	4,393	4,230	4,079	3,938	3,807	3,684	3,569	3,461	3,359
800/42	7,403	7,013	6,662	6,345	6,057	5,793	5,552	5,330	5,125	4,935	4,759	4,595	4,442	4,298	4,164	4,038	3,919
800/48	8,460	8,015	7,614	7,251	6,922	6,621	6,345	6,091	5,857	5,640	5,439	5,251	5,076	4,912	4,759	4,615	4,479

¹⁾ Rain yield factor with a rainfall duration of 15 min. and annual recurrence

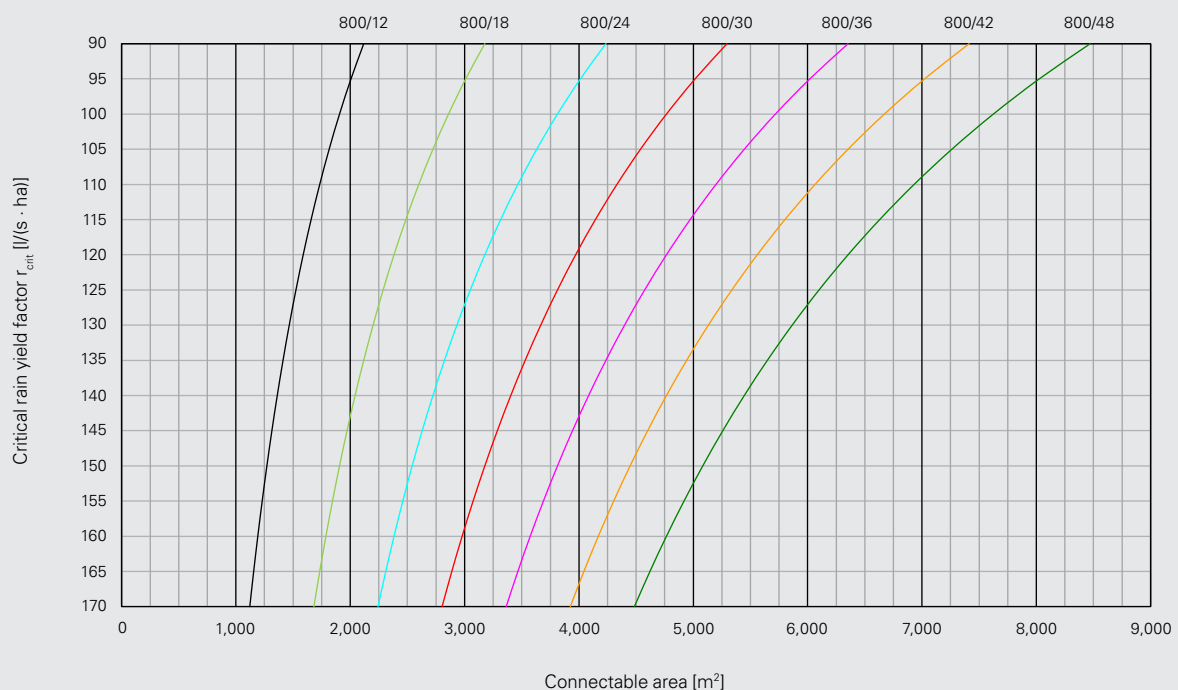

SediPipe performance characteristics, connectable area A_{imp} depending on the required pass-through value acc. to DWA-M 153, D21

Cleaning

Common sewer cleaning technology methods are used to clean the system. All work is performed without requiring access from above ground. The system keeps a permanent water level which ensures that the sediment remains muddy. The contents of the system are vacuumed in the start segment via the inspection opening. To do so, first remove the maintenance plate, which clears the sediment area. Depending on the requirements, you can also clean the target segment via the inspection opening. Afterwards, the system is flushed, refilled and can be operated again.

NB

Please refer to the installation and maintenance manual for a detailed description.
www.fraenkische.com

1. Remove the maintenance plate from the start segment

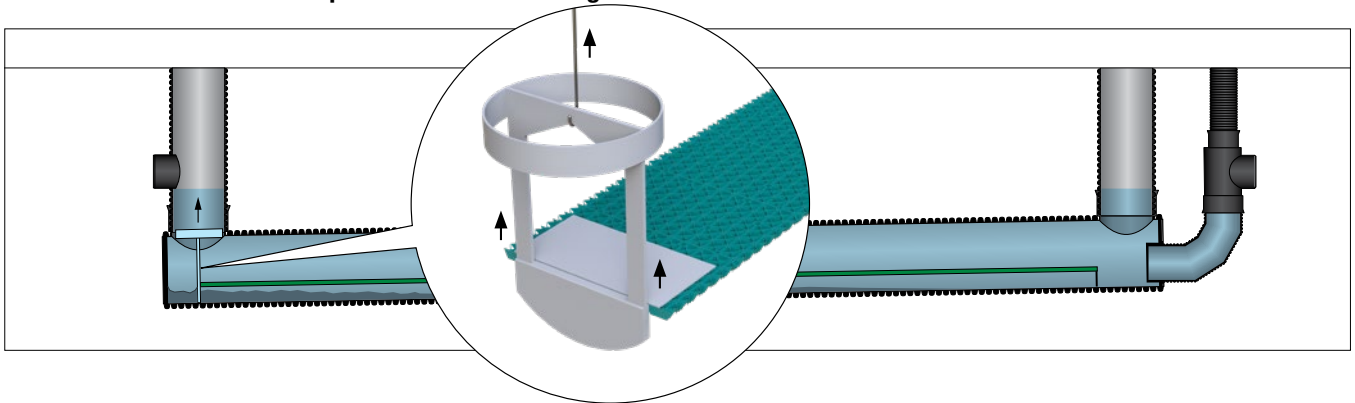

2. Emptying with vacuum hose

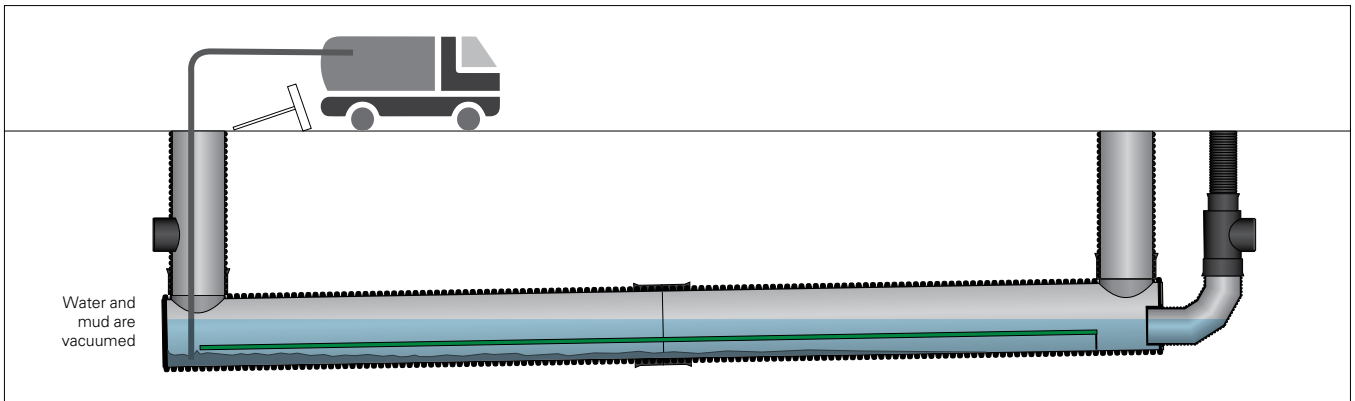

3. Cleaning with vacuum and flush hose

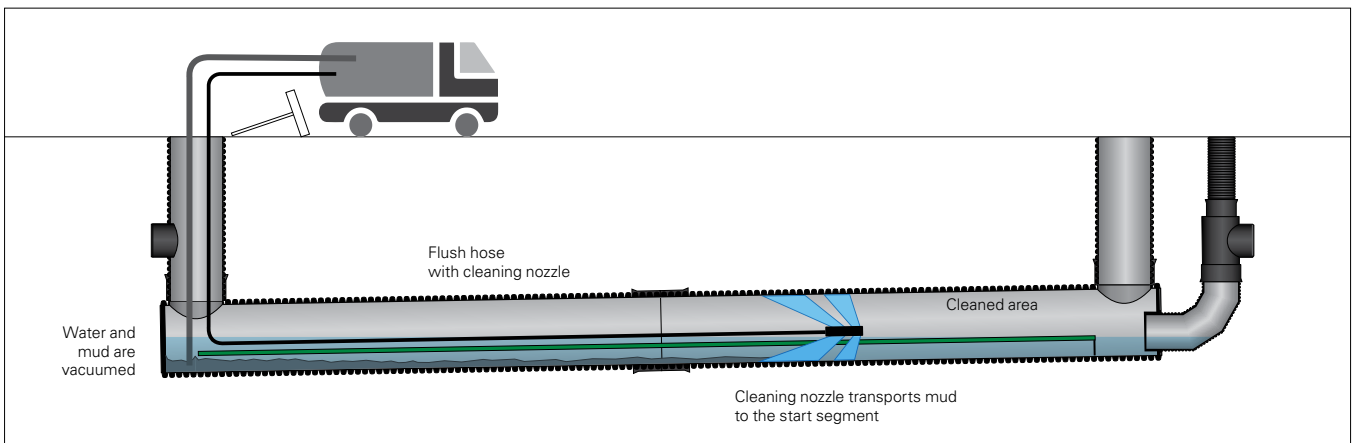

Connection geometries

Connection angle

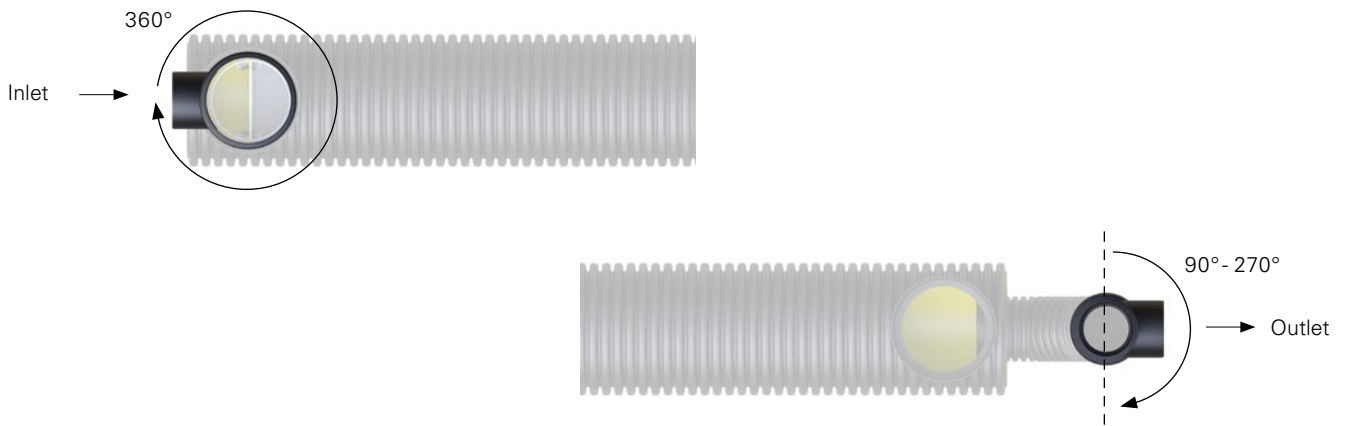

Arrangement of multiple systems

The following describes the recommendations for the arrangement of multiple systems and the required minimum distances. We draw your attention to the fact that for installation clearances between distribution and combining units and the treatment system, the respective fitting dimensions of the connection pipes and their space requirements must be considered for the installation in addition to the general minimum clearances specified by standards.

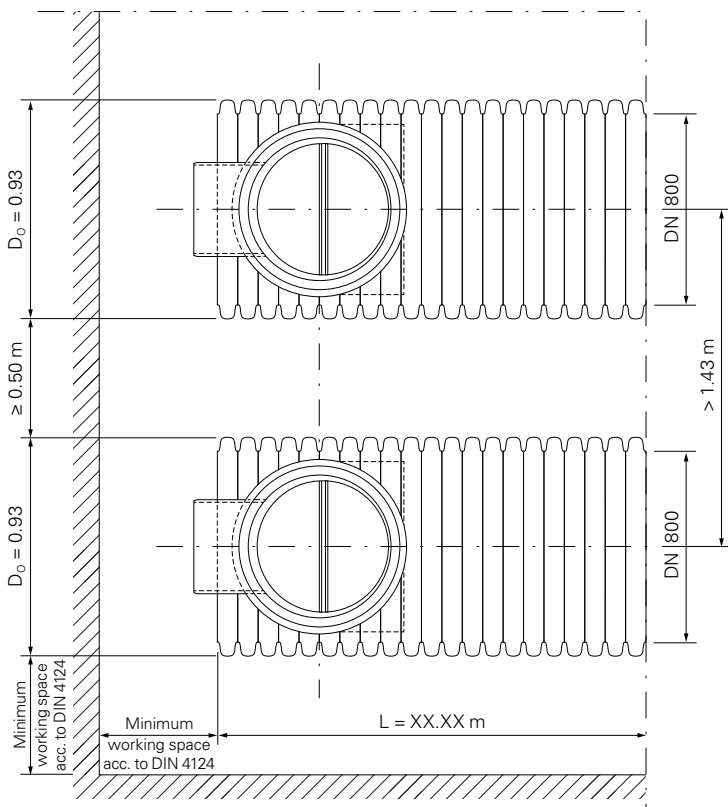

Technical data

In case of SediPipe 800, inlet and outlet are same level.
 This allows minimum installation depths of the drainage pipe and/or the downstream systems.

SediPipe 800 can be used universally for a wide range of purposes:

- Discharge into a surface waterbody, the sewer or into a storage/infiltration system
- Installation upstream of or parallel to a storage/infiltration system

The inlet at the start segment is 360 degrees rotatable. The inlet and outlet diameter is DN/OD 400.
 The flow direction can be adjusted to a desired angle between 90° and 270° on site.
 The system can therefore be easily adapted to on-site requirements.

With soil temperatures up to 23° C, depending on installation temperatures, the stability of the system has been designed for a maximum installation depth of 6 m, including groundwater of 5 m over the lowest component.

The minimum depth of the system derives from the minimum required distance between the pipe crown of the inlet channel and the bottom edge of the BARD ring of 35 cm.

When using a conventional class D cover without equalisation ring with a connection DN/OD 400, this corresponds to an inlet channel soil depth of 1.10 m.

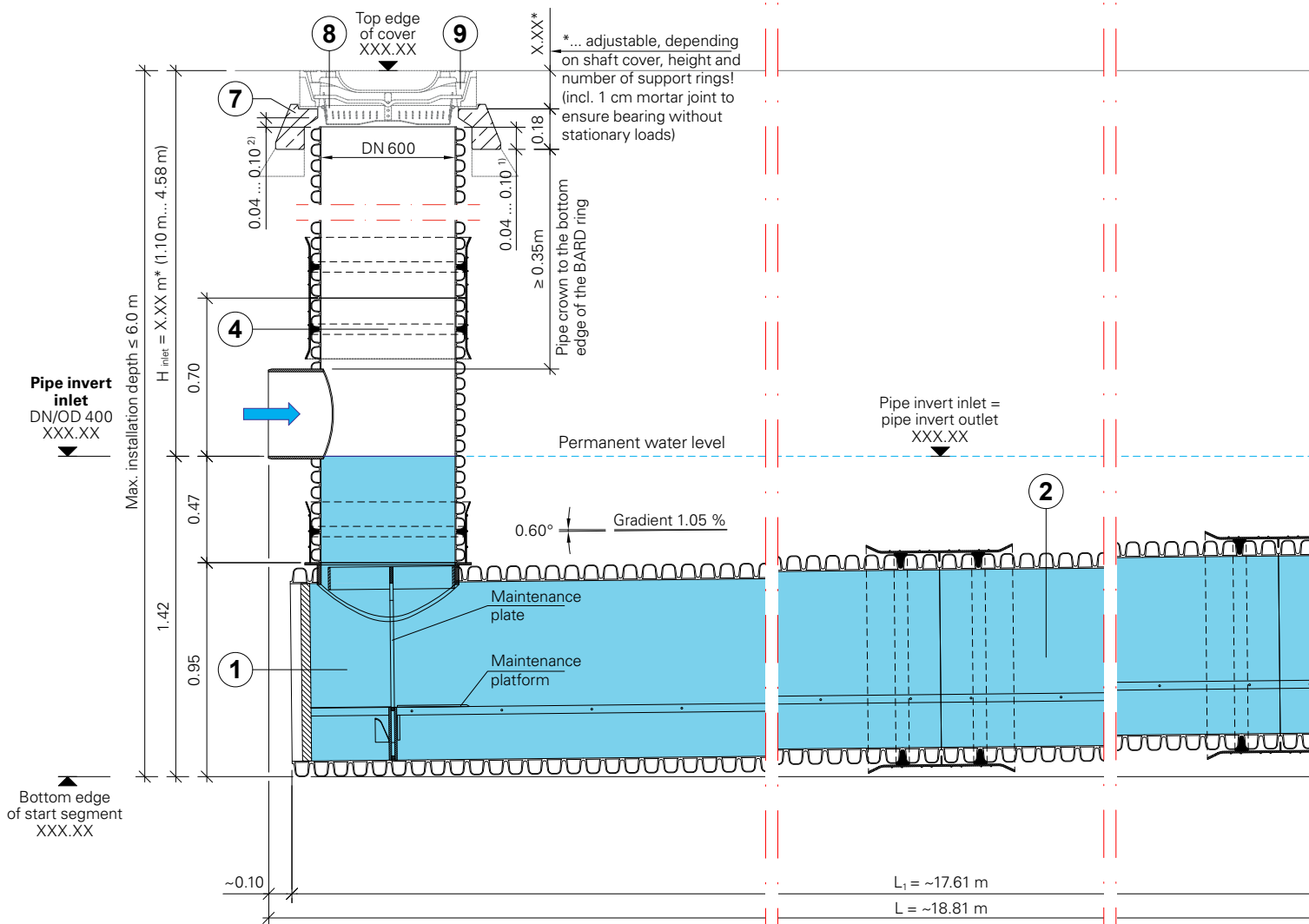

Example SediPipe 800/18 section

Sizes

SediPipe 800	800/12	800/18	800/24	800/30	800/36	800/42	800/48
Total length "L" [m]	12.94	18.81	24.67	30.54	36.41	42.28	48.15
Min. height inlet H_{inlet} / outlet H_{outlet} [m]	≥ 1.10	≥ 1.10	≥ 1.10	≥ 1.10	≥ 1.10	≥ 1.10	≥ 1.10
Max. height inlet H_{inlet} [m]	≤ 4.65	≤ 4.58	≤ 4.51	≤ 4.44	≤ 4.37	≤ 4.30	≤ 4.23
Max. height outlet H_{outlet} [m]	≤ 4.76	≤ 4.76	≤ 4.76	≤ 4.76	≤ 4.76	≤ 4.76	≤ 4.76
Height difference start/target segment ΔH [m]	0.12	0.19	0.25	0.32	0.39	0.46	0.53
Diameter of the sedimentation path [mm]	800	800	800	800	800	800	800
Length of the sedimentation path "L ₁ " [m]	11.74	17.61	23.47	29.34	35.21	41.08	46.95
Sedimentation path gradient [%]	0.98	1.05	1.09	1.10	1.12	1.13	1.13
Sedimentation path gradient as angle α	0.56°	0.60°	0.62°	0.63°	0.64°	0.65°	0.65°
Collecting volume of light liquids [litres] ¹⁾	1,770	2,200	2,440	2,510	2,530	2,550	2,570
Collecting volume of the mud chamber [litres]	1,030	1,590	2,140	2,700	3,260	3,810	4,370
Permanent water level volume [litres]	6,020	8,890	11,750	14,610	17,480	20,340	23,200

¹⁾ Retention of light liquids in case of spills in dry weather

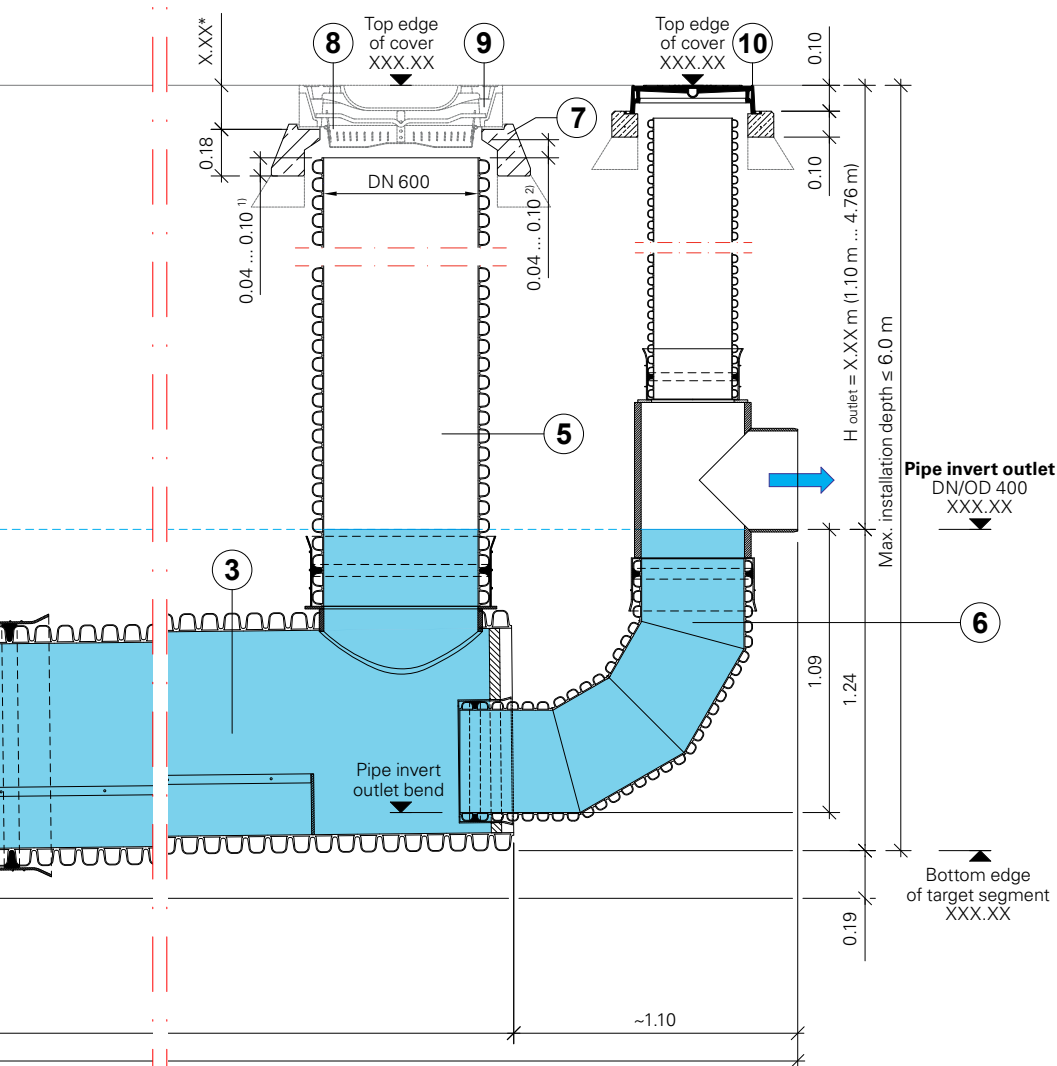

- ① **Start segment DN 800**
with lower flow separator, maintenance plate and maintenance platform
- ② **Sedimentation pipe DN 800**
(L ~6 m) with lower flow separator
- ③ **Target segment DN 800**
with lower flow separator
- ④ Inlet set for start segment with extension pipe DN 600
- ⑤ Extension pipe for target segment DN 600
- ⑥ Outlet bend DN 400 with outlet DN/OD 400 and extension pipe DN 300
- ⑦ BARD ring (concrete support ring class D, inside Ø 745 mm)
- ⑧ Dirt trap acc. to DIN 1221 ³⁾
- ⑨ Shaft cover CW 610 ³⁾
- ⑩ Shaft cover CW 410 class D without ventilation openings incl. concrete support ring

¹⁾ Insertion area
²⁾ Compensating area
³⁾ to be ordered/supplied on site

Product range overview

The system is comprised of a SediPipe 800 basic set and, depending on the sewer depth, a connection and joint piece set and the covers to be supplied on site.

SediPipe® 800 basic set



Components:

- Start segment DN 800 incl. sedimentation path
- Target segment DN 800 incl. sedimentation path
- Depending on the length, additional sedimentation pipe with lower flow separator DN 800 incl. required couplings and profile sealing rings
- Outlet bend DN 400
- Incl. profile sealing rings

Product	Technical data	Cat. no.
SediPipe 800/12 basic set	Sedimentation path DN 800, 12 m length (2 x 6 m)	51596812
SediPipe 800/18 basic set	Sedimentation path DN 800, 18 m length (3 x 6 m)	51596818
SediPipe 800/24 basic set	Sedimentation path DN 800, 24 m length (4 x 6 m)	51596824
SediPipe 800/30 basic set	Sedimentation path DN 800, 30 m length (5 x 6 m)	51596830
SediPipe 800/36 basic set	Sedimentation path DN 800, 36 m length (6 x 6 m)	51596836
SediPipe 800/42 basic set	Sedimentation path DN 800, 42 m length (7 x 6 m)	51596842
SediPipe 800/48 basic set	Sedimentation path DN 800, 48 m length (8 x 6 m)	51596848

SediPipe® 800 connection sets – for sewer depths up to 2.5 m



Components:

- Inlet set for start segment with coupling and extension pipe DN 600
- Extension pipe for target segment DN 600
- Extension pipe for outlet bend DN 300
- Incl. profile sealing rings
- Incl. 2x class D BARD rings
- Tee for outlet with connection DN/OD 400
- Shaft cover CW 410, class D 400 without ventilation openings, incl. concrete support ring

Product	Technical data	Cat. no.
Connection set SediPipe 800 for sewer depths up to 2.5 m	SediPipe 800 connection set for sewer depths up to 2.5 m Inlet: 1x DN/OD 400 Outlet: 1x DN/OD 400	51597862
SediPipe 800 connection set including additional connection for sewer depths up to 2.5 m	SediPipe 800 connection set for sewer depths up to 2.5 m Inlet: 1x DN/OD 400, 2x DN/OD 315 Outlet: 1x DN/OD 400	51597864

SediPipe® 800 connection sets – for sewer depths greater than 2.5 m



Components:

- Inlet set for start segment with coupling and extension pipe DN 600
- Extension pipe for target segment DN 600
- Extension pipe for outlet bend DN 300
- Incl. profile sealing rings
- Incl. 2x class D BARD rings
- Tee for outlet with connection DN/OD 400
- Shaft cover CW 410, class D 400 without ventilation openings, incl. concrete support ring

Product	Technical data	Cat. no.
Connection set SediPipe 800 for sewer depths greater than 2.5 m	SediPipe 800 connection set for sewer depths greater than 2.5 m Inlet: 1x DN/OD 400 Outlet: 1x DN/OD 400	51597865
SediPipe 800 connection set including additional connection for sewer depths greater than 2.5 m	SediPipe 800 connection set for sewer depths greater than 2.5 m Inlet: 1x DN/OD 400, 2x DN/OD 315 Outlet: 1x DN/OD 400	51597867

Accessories



Product	Technical data	Cat. no.
15° bend for sedimentation path	15° bend incl. coupling DN 800 and 2 profile sealing rings	51597872
30° bend for sedimentation path	30° bend incl. coupling DN 800 and 2 profile sealing rings	51597873
45° bend for sedimentation path	45° bend incl. coupling DN 800 and 2 profile sealing rings	51597874
15° bend for sedimentation path with inspection opening	15° bend with openable coupling DN 600 for inspection incl. coupling DN 800 and 2 profile sealing rings	51597875
30° bend for sedimentation path with inspection opening	30° bend with openable coupling DN 600 for inspection incl. coupling DN 800 and 2 profile sealing rings	51597876
45° bend for sedimentation path with inspection opening	45° bend with openable coupling DN 600 for inspection incl. coupling DN 800 and 2 profile sealing rings	51597877
Extension pipe for inspection opening	2 m pipe length; DN 600; incl. profile sealing ring and BARD ring	51597881
	3 m pipe length; DN 600; incl. profile sealing ring and BARD ring	51597882
	6 m pipe length; DN 600; incl. profile sealing ring and BARD ring	51597883
Extension for extension pipe	1 m pipe length; DN 600; incl. coupling and profile sealing rings	51597884
	2 m pipe length; DN 600; incl. coupling and profile sealing rings	51597885
	3 m pipe length; DN 600; incl. coupling and profile sealing rings	51597886

To be ordered/supplied on site

Product	Technical data	Cat. no.
Covers CW 610	with ventilation	To be ordered/ supplied on site
Dirt trap		
Support rings	(optional)	

Contact

Contact persons Königsberg headquarters

International Sales Director

Horst Dörr +49 9525 88-2490
horst.doerr@fraenkische.de

International Sales

Dinah Wächter +49 9525 88-8155
dinah.waechter@fraenkische.de

Technology

Pedro Simões +49 9525 88-8360
pedro.simoes@fraenkische.de

European Sales Director

Klaus Lichtscheidel +49 9525 88-8066
klaus.lichtscheidel@fraenkische.de

European Sales

Julia Möller +49 9525 88-2394
julia.moeller@fraenkische.de

Carolin Diem +49 9525 88-2229
carolin.diem@fraenkische.de

Viktoria Majewski +49 9525 88-2103
viktoria.majewski@fraenkische.de

Jennifer Gernert +49 9525 88-2569
jennifer.gernert@fraenkische.de

Fabian Thiergärtner +49 9525 88-2197
fabian.thiergaertner@fraenkische.de

Fax +49 9525 88-2522



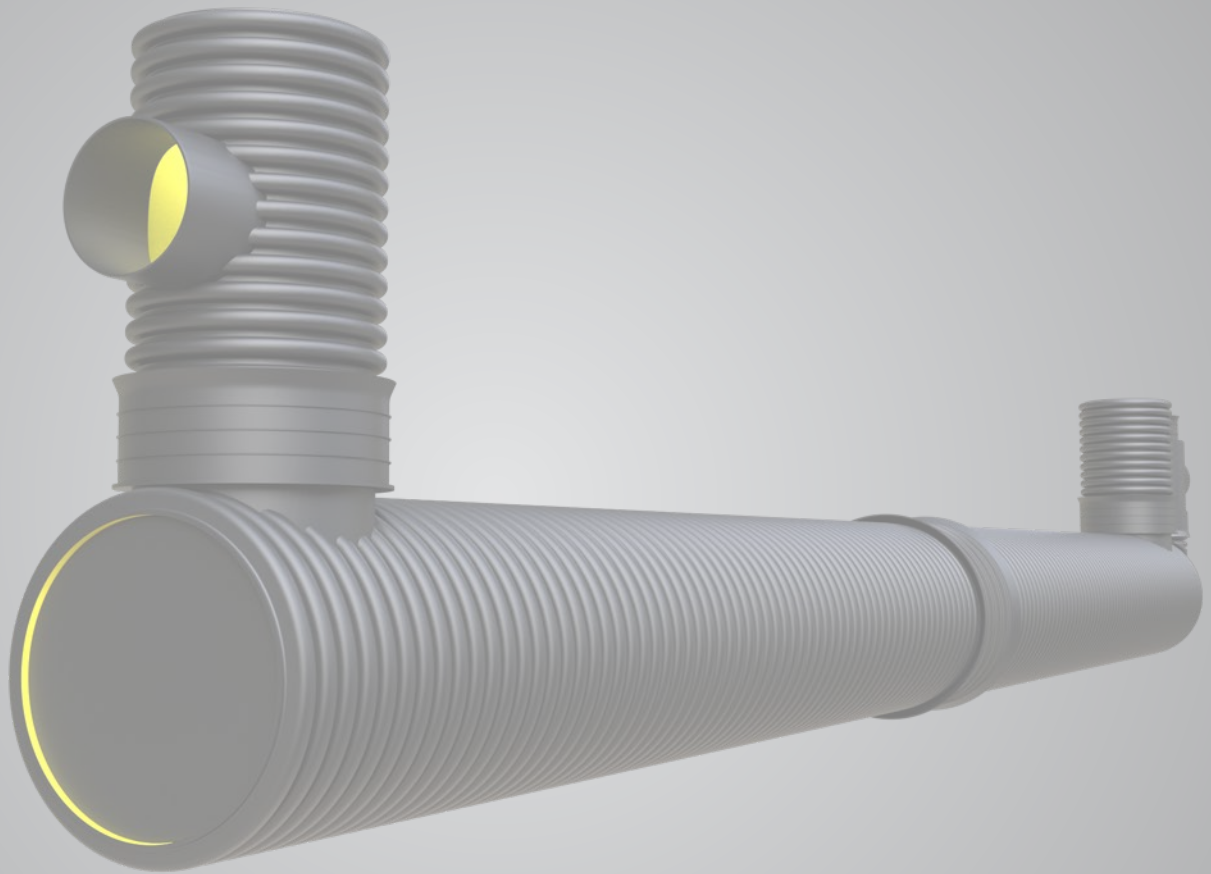

© www.adobestock.com



FRÄNKISCHE

FRÄNKISCHE Rohrwerke Gebr. Kirchner GmbH & Co. KG | Hellinger Str. 1 | 97486 Königsberg/Germany
Phone +49 9525 88-2200 | Fax +49 9525 88-92200 | marketing@fraenkische.de | www.fraenkische.com

EN.90163/1.05.22 | Subject to change without notice | Cat. no. 5000-1853-00 | 05/2022 [DE.90161/1]

